

C Series  
60 mA Digital Output  
Isolated Safety Barrier



→ Introductions

By switch signals controlling, this isolated safety barrier transfers the digital signals (wet contact) from a safe area into current signals to a hazardous area, and drives field device like intrinsically safe valves, audible alarms, etc.

The input and output are galvanically isolated from each other. The apparatus was designed with various kinds of advantages, for instance, high reliability and fast response, etc. It can be interfaced with all kinds of device and DCS, PLC and other systems.

→ Parameters

**Explosive-proof grade:** [Ex ia Ga] IIB

**Loop Power supply:** 20 V DC ~ 30 V DC

**Input (5, 6; 7, 8):**

Input signal: Wet contact

**Output (1, 2; 3, 4):**

Max. Output voltage: 22 V

Min. Output voltage: 12 V

Output current: ≤ 60 mA

**Electromagnetic compatibility:** Accordance to IEC 61326-3-1

**Dielectric strength (1 mA leakage current, 1 minute test time):**

≥ 3000 V AC (intrinsically safe side / non-intrinsically safe side)

**Insulation resistance:** ≥ 100 MΩ (Input /Output)

**Parameters certified by National Supervision and Inspection Center for Explosion Protection and Safety of Instrumentation (NEPSI):**

U<sub>m</sub>: 250 V

Terminals 1, 2; Terminals 3, 4:

U<sub>0</sub>: 25.2 V I<sub>0</sub>: 170 mA P<sub>0</sub>: 1.08 W C<sub>0</sub>: 0.82 μF L<sub>0</sub>: 4 mH

**Ambient conditions:**

Operation temperature: -20 °C ~ +60 °C

Relative humidity: 10% RH ~ 90% RH (40 °C)

Atmosphere pressure: 80 kPa ~ 106 kPa

Storage temperature: -40 °C ~ +80 °C

→ Support model type

Model number	Single input, single output	Double input, double output
NPEXB-C513L	■	
NPEXB-C5D13L		■

→ Output equivalent circuit

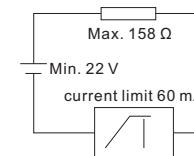

→ Output characteristics diagram

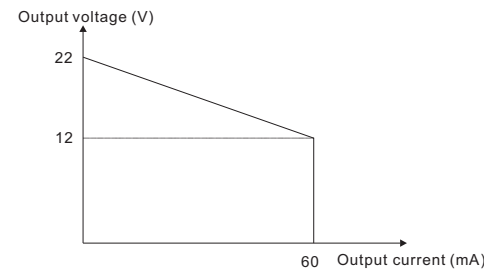

→ Wiring diagram

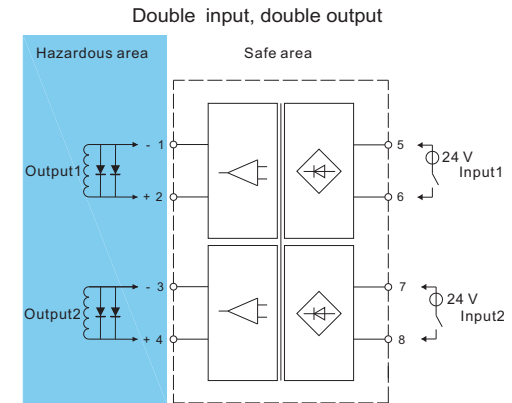
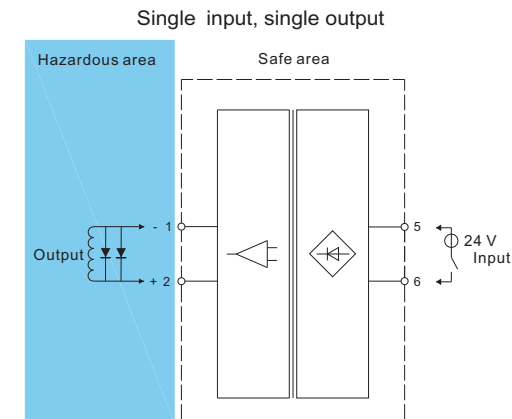

→ Dimension

Width × Height × Depth: 12.8 mm × 110 mm × 117 mm

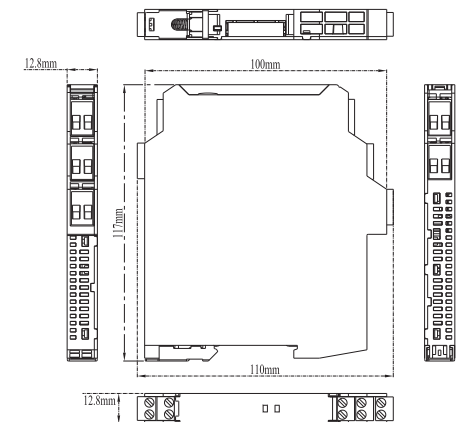

→ Applications

This apparatus is used for transmitting signals between field devices and process control system. It can be used to connect field equipment which is installed in potentially explosive gas environment, and protect the intrinsically safe equipment in a hazardous area by limiting current and limiting voltage.

The apparatus can convert the wet contact signals from a safe area into current signals to a hazardous area by isolation, It is used to drive intrinsically safe apparatus. The LED indicator on the front side can reflect the apparatus

output status.

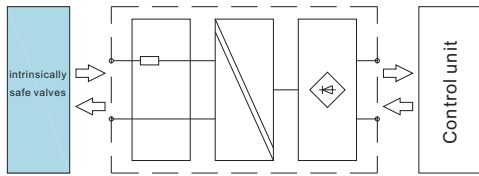

→ Installation

- The apparatus can be installed on the DIN 35 mm standard rail which is corresponding to DIN IEC 60715. The must be snapped onto the rail, and never slanted or tipped to the side.
- Installation and disassembly steps are shown in following figures:

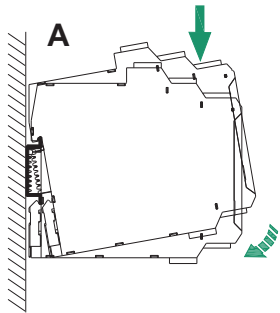

A. Snap metal lock onto mounting rail, then rotate the safety barrier, as figure A, press down the safety barrier onto mounting rail.

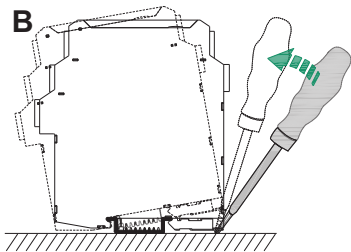

B. Pry the metal lock off the rail with screwdriver as arrow shown, pull downward the springs, and rotate the safety barrier.

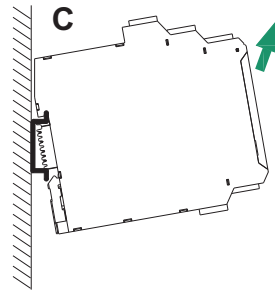

C. Remove the safety barrier as arrow shows.

- As far as possible to mount it vertically, In order to dissipation the heat of the apparatus.

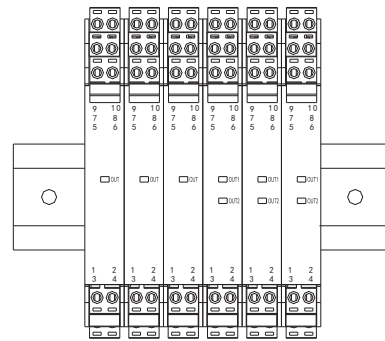

Vertically installation

→ Light indication

- **OUT1 and OUT2 (Dual channel) or OUT (Single channel):**

Output status indicators. When the output loop voltage is normal, the indicators turns to yellow.

→ Attention

- Isolated Safety Barriers degree of protection is IP 20 and must be protected from undesirable ambient conditions (waterproofing, small foreign objects). It is suitable for installation in the control room or high density field cabinet, DIN 35 mm installation is convenient for installation and displacement.
- The devices were designed for use in pollution degree 2 and overvoltage category III as per IEC/EN 60664-1. If used in areas with higher pollution degree, the devices need to be protected accordingly.
- Installation position shall not be affected by strong

mechanical vibration; impact and electromagnetic induction from signal terminal and power supply, should conformity with the requirements on electromagnetic interference resistance of products in Class 3 industrial field atmosphere stipulated in IEC 61000-4; the atmosphere shall be free from gases that are corrosive to metal and plastic components.

- The apparatus must be installed, connected and adjusted by qualified personnel in non-hazardous area according with the instruction manual.
- The operator must strictly comply with the relevant local safety standards and guidelines.

→ Supplementary instructions

- Our company reserves the right to change the product information without prior notification to the user. If the contents of the description are different from website or sample, this description shall prevail.